

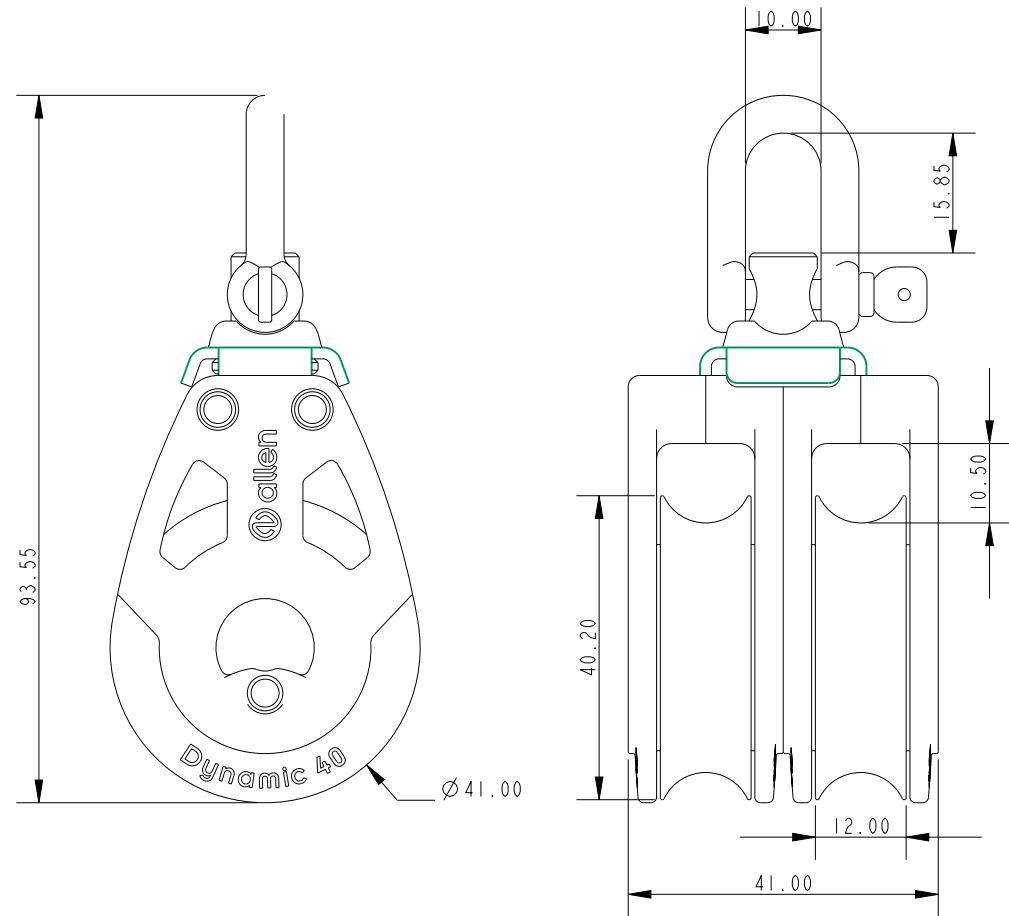

SCALE 1:1



Specification

Length mm	Line Diameter mm	Shackle Pin mm	Breaking Load kg	MWL kg	Weight g
93.55	10	5	1150	500	109

DIMENSIONS FOR REFERENCE ONLY
 allenbrothers.co.uk
 +44(0)1621 772477

Title	Description
A20402-REF	Double