

SCALE 1:2

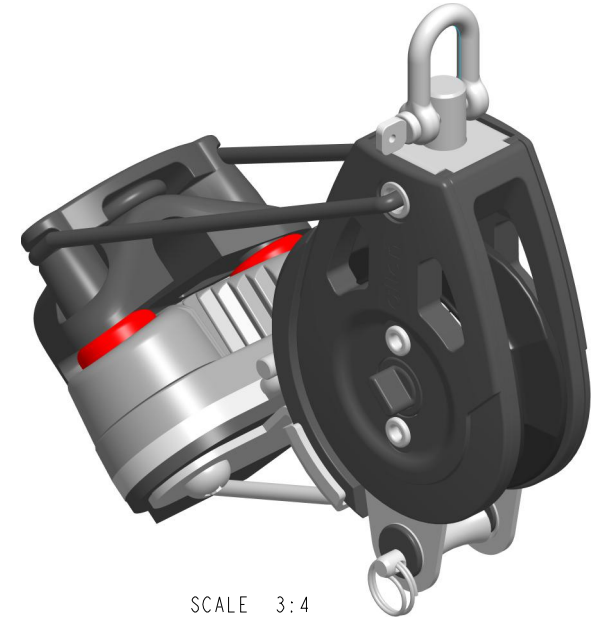

SCALE 3:4

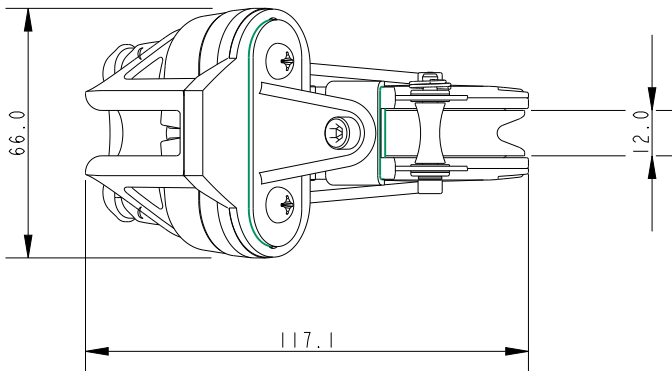

25° of Adjustment,
with 3 Positions at
12.5° Intervals

Specification

Sheave Dia. mm	Length mm	Line Diameter mm	Shackle Pin mm	Breaking Load kg	MWL kg	Weight g	Bearing Detail
50	125.09	8	4	700	200	64.6	Delrin

DIMENSIONS FOR REFERENCE ONLY
allenbrothers.co.uk
 +44(0)1621 772477

Title	Description
A2151-REF	Pro-Ratchet With Becket And Cleat